



CLIMATE CONTROL SYSTEMS / AGRICULTURE & FORESTRY

HARD WORK – PERFECT TEMPERATURE

Heating, Air Conditioning & Cabin Pressurization Solutions

CLIMATE CONTROL SYSTEMS

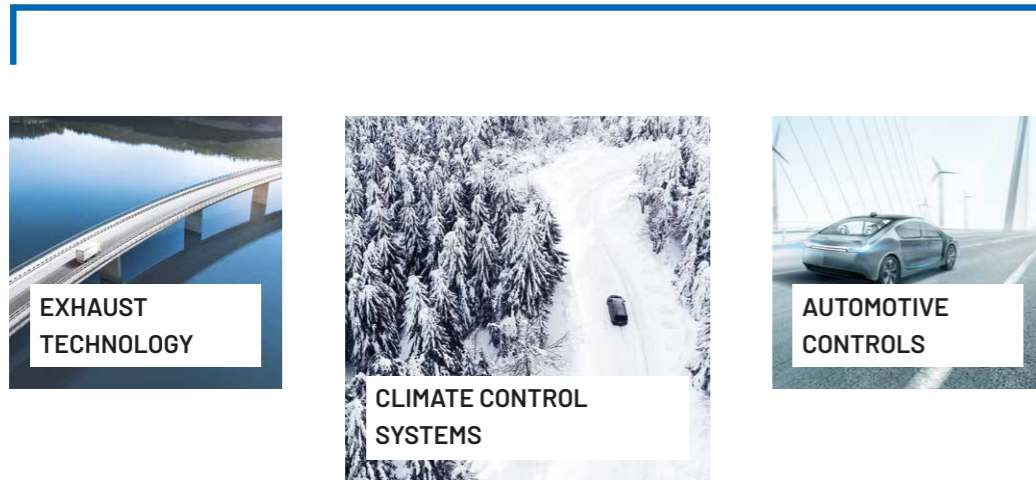

- Enhanced application expertise for heating and cooling
- Extensive product portfolio for heating and cooling
- Accessories for large variety of applications
- Kalori A/C specialists merged into one powerful team

INNOVATIVE MARKET AND CUSTOMIZED SOLUTIONS



EXPERTS IN COOLING AND HEATING

FOR SPECIAL VEHICLES

Ideal conditions for agriculture & forestry machinery – the perfect solution for every need

As a heating and cooling system supplier, Eberspächer provides ideal thermal management for agriculture & forestry machinery. Our climate control systems offer enhanced comfort and safety: drivers can enjoy pre-heated engines and warm cabs in winter and pleasantly cool drier cabs in summer. Machine operators demonstrably perform better and are more alert in a cab with a pleasant climate. Additionally we also help customers comply with statutory workplace regulations and ensure operational readiness. Thanks to our experience in HVAC development, application and production, we can offer customized heating and air-conditioning applications – **all from a single source.**

[Agriculture & forestry]



OUR PRODUCT PORTFOLIO

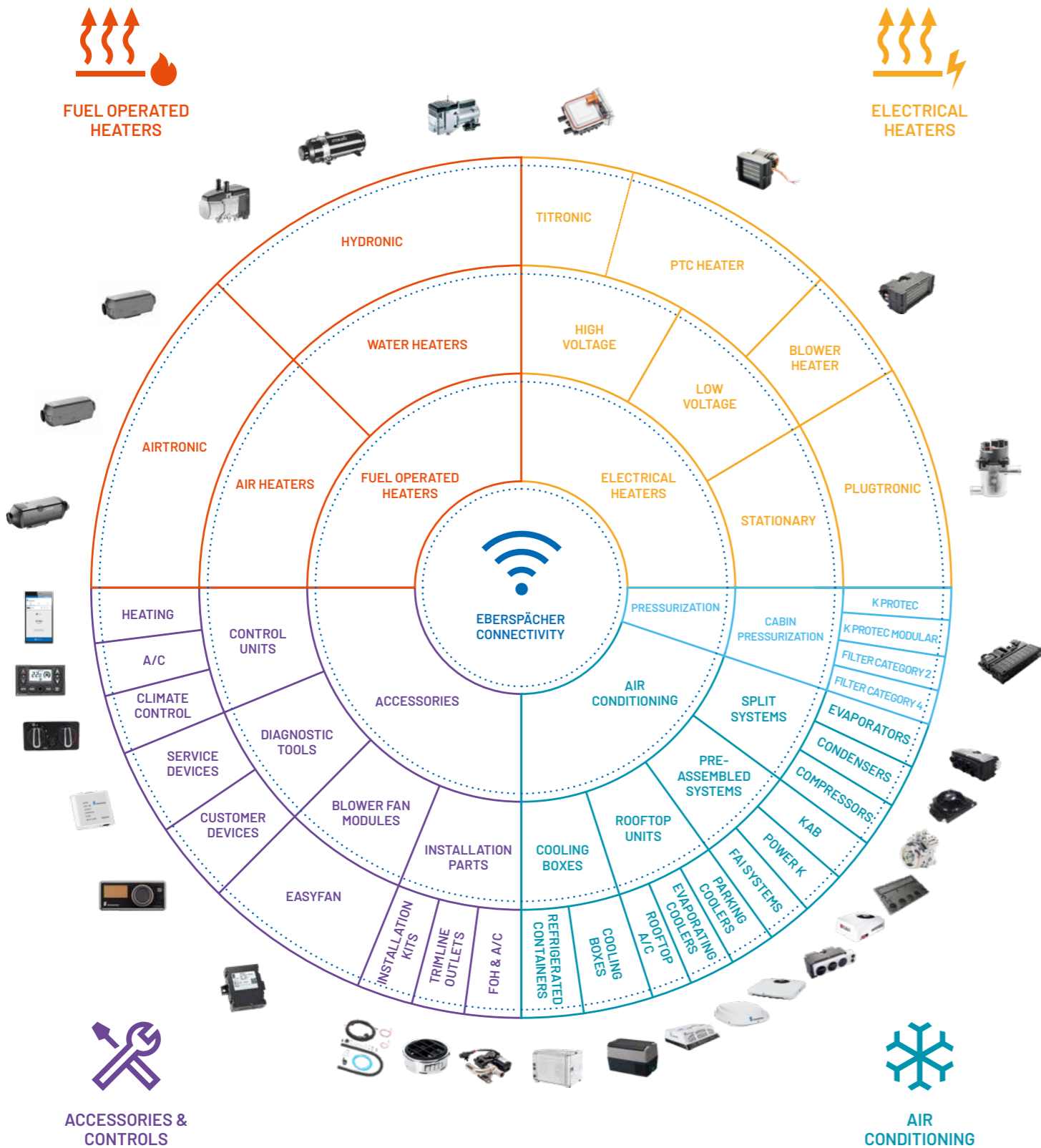

PRODUCTS FOR AGRICULTURE & FORESTRY MACHINERY

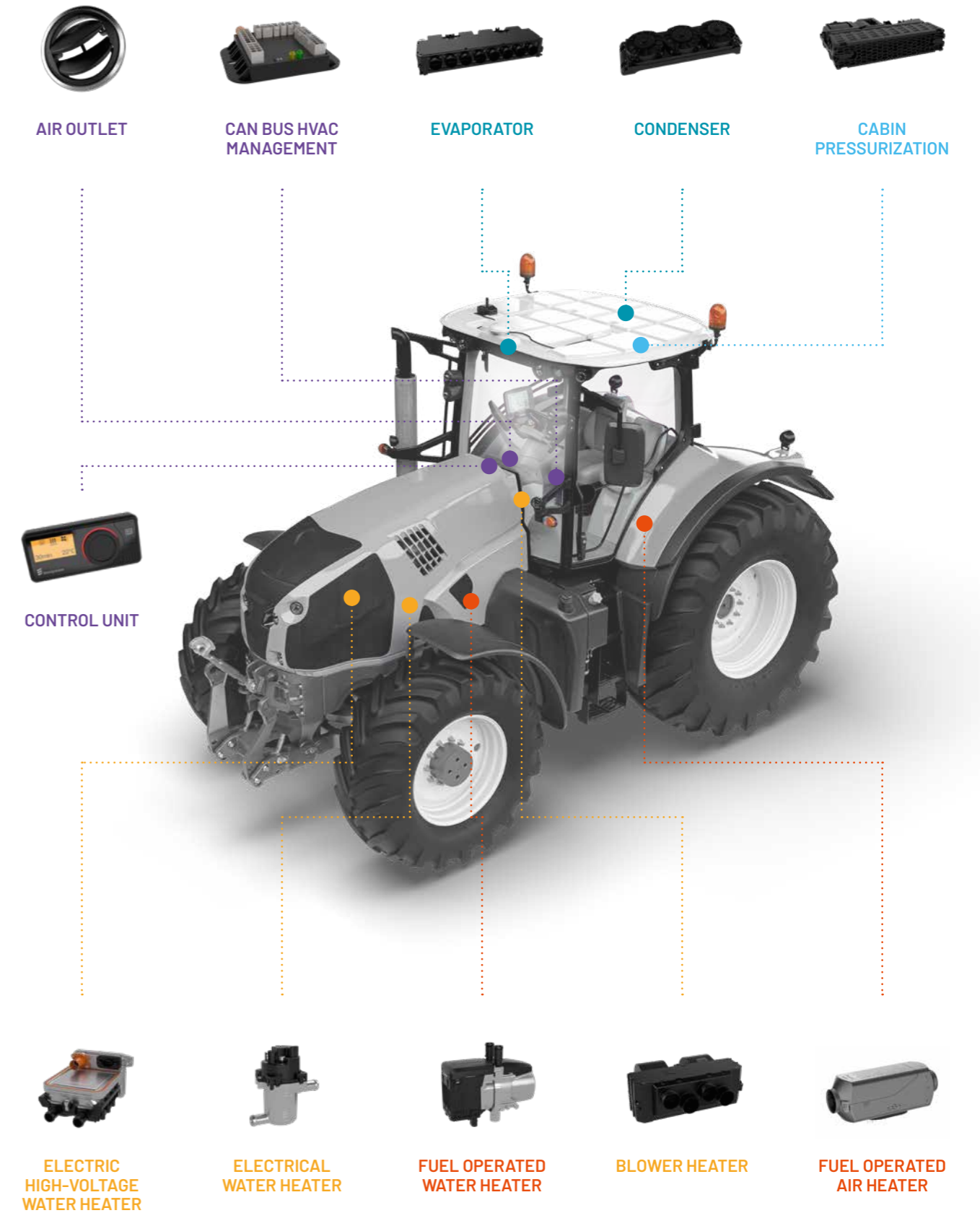

SAME PRODUCT & SYSTEM DESIGN FOR COMBUSTION ENGINE & ELECTRIC DRIVE SOLUTIONS

With our identical product design for different drive trains you can simply adapt the HVAC & EHVAC system integration:

**SAME, SAME.
BUT DIFFERENT.**

EASY HANDLING FOR EVERY DEVELOPER

- Same design
- Same size
- Same mounting positions

For Electric & Internal Combustion Engine drive.

EXAMPLE FOR AN EASY SYSTEM APPLICATION FOR BOTH INTERNAL COMBUSTION ENGINE & ELECTRIC DRIVE

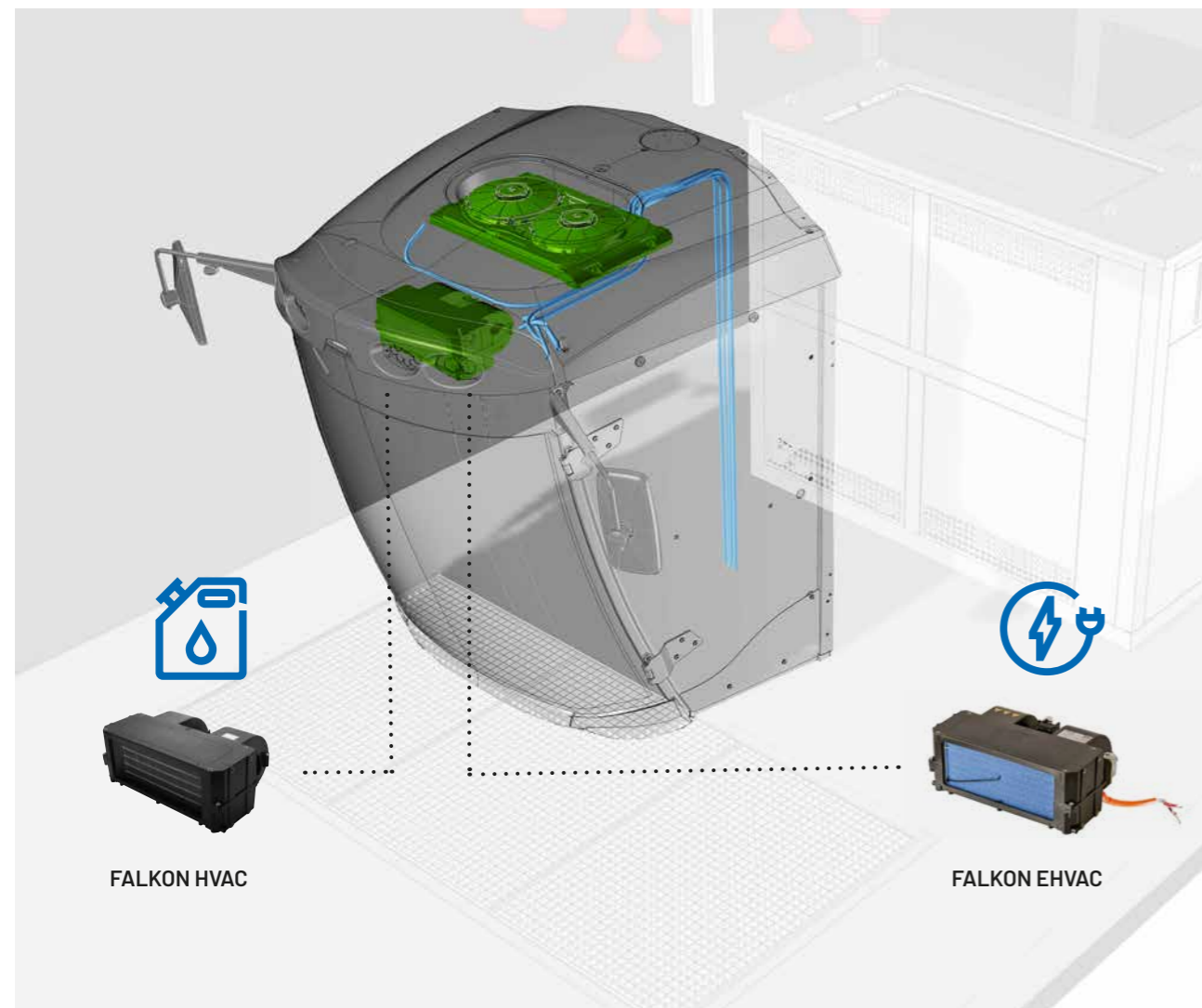

| No additional HVAC development for electric vehicles needed!



ALL OUR PRODUCTS ARE AVAILABLE AS HVAC AND EHVAC VERSIONS FOR EVERY REQUIREMENT - EXAMPLES



HVAC
Internal
Combustion
Engine



EHVAC
Electric
Drive

Kool 2



Super K



Falkon



MK0



VK9



RK9



| Our entire product portfolio is available in our heating and air conditioning catalog.

AIR CONDITIONING & HEATING SYSTEMS



HORIZONTAL EVAPORATORS FOR SPLIT SYSTEMS



- Large portfolio enables solutions to be installed for almost every cabin
- Available as A/C only, heating only or HVAC version
- Also available for battery electric vehicles using a PTC heating element

Version		Super K	Kool	Falkon
Cooling performance	kW	3.5	4.5	7.7
Heating performance	kW	4.3	6.6	10
Airflow	m ³ /h	440	520	660
Electrical consumption	W	100	180	360
Main dimensions	mm	216 x 368 x 137	261 x 384 x 158	297 x 432 x 167

VERTICAL EVAPORATORS FOR SPLIT SYSTEMS



- Directional scrolls can be positioned independently
- With integrated electrical flap on the air intake for outside air / circulating operation
- Available as A/C only, heating only or HVAC version

Version		MK1
Cooling performance	kW	7
Heating performance	kW	7.8
Airflow	m ³ /h	700
Electrical consumption	W	360
Main dimensions	mm	159 x 428 x 443

PRE-ASSEMBLED HVAC EVAPORATOR SYSTEMS - KAB



- Pre-assembled HVAC evaporator systems for integration in the cab ceiling
- System with integrated air distribution and manual operating elements
- Easy to install in the cab roof
- Over 10 system variants available for every requirement

Version		HVAC 4.3 / 3.5	HVAC 6.6 / 4.5	HVAC 10 / 7.7
Cooling performance	kW	3.5	4.5	7.7
Heating performance	kW*	4.3	6.6	10.0
Airflow	m ³ /h*	440	520	725
Electrical consumption	W	100	180	360
Main dimensions	mm	589 x 380 x 137.5	589 x 380 x 160.5	589 x 380 x 169

*Depending on model

| Our entire product portfolio is available in our heating and air conditioning catalog.

ROOFTOP A/C UNIT - RK9



- Also available for battery electric vehicles using a PTC heating element
- Can integrate an electric compressor (SH version)
- Also available as air conditioning only version

Version		RK9
Cooling performance	kW	up to 9
Heating performance	kW	up to 10
Weight	kg	23
Airflow	m ³ /h*	725
Main dimensions	mm	932 x 581 x 192

*Depending on model

PRE-ASSEMBLED HVAC EVAPORATOR SYSTEMS - HK EVO4 HEAD LINER



- Thinnest HVAC on the market.
- The ceiling HK EVO4 Head Liner is used in large cabins operating in a harsh environment, very hot climate or high thermal load
- It is fixed to the ceiling and its very low thickness guarantees a preserved livability
- The integrated control panel controls the temperature and ventilation speed.
- The water flow control valve is integrated in the evaporator body
- At the rear, the air inlet is protected by a filter accessible without tools
- Available as air-conditioning only version

Version		HK EVO4 Head Liner
Cooling performance	kW	8.6
Heating performance	kW	9.5
Airflow	m ³ /h*	1300
Electrical consumption	W*	190
Main dimensions	mm	487 x 1000 x 132

*Depending on model

| Our entire product portfolio is available in our heating and air conditioning catalog.

ELECTRICAL HEATING & AIR CONDITIONING SYSTEMS



HIGH-VOLTAGE COOLANT HEATER - TITRONIC



- Third generation of high-voltage PTC water heater for electric vehicles
- Reliable and powerful PTC technology offering a high heating performance of 5 kW*
- Six heat stages

Version	CHHV 50 G3	
Heating performance	kW	5.0*
Main dimension	mm	160 x 159 x 105
Weight	kg	2.0
Operating voltage range (HV)	V	250 - 450 / 12
Interfaces	LIN 2.1	

* Un = 350 V, Tco = 60°C, Qco = 10 l/min, Coolant = 50:50

ELECTRICAL WATER HEATER - PLUGTRONIC



- Vehicle pre-heating system, consisting of a 230 V-heater for pre-heating the engine and interior, a water pump, wiring and an electronic charger
- Can be combined with vehicle-specific kits
- Flexible positioning with a water pump as standard for simple installation
- Water pump available for 12 V or 24 V
- 20 mm water spigot diameter

Version	800	1850	
Heating performance	kW	0.8	1.85
Main dimension	mm	151 x 131 x 81	
Weight	kg	0.8	
Operating voltage range (HV)	V AC	230	
Interfaces	V DC	12 / 24	

ELECTRICAL BLOWER HEATER



- Compact size perfectly suited to small cabins
- Electric heater with secured PTC element and equipped with safety thermal switch
- Water blower heater also available

Version	ALIZE 2 ELEC	KELEC EV01	KELEC EV02	
Heating performance	kW*	1.6 - 2.2	0.85 - 1.7	
Airflow	m³/h*	210	230	350
Ventilation speed		3		
Operating voltage range	V DC*	PTC from 24 to 800		
Ventilation voltage	V*	12 / 24		
Main dimension	mm	189 x 175 x 132	235 x 255 x 114	344 x 273 114

*Depending on model

ELECTRICAL HVAC VERTICAL EVAPORATOR



- Vertically mounted hybrid evaporator for conventional A/C with PTC heating element
- Features with directional scrolls which can be pivoted to direct the air in the right direction
- Also available as non-electric version with water heat exchanger

Version	MK0 EHVAC		VK9 EHVAC
Heating performance	kW	2.2	3
Cooling performance	kW	4.3	7.5 or 8.5*
Airflow	m³/h	390	600 or 800*
Electrical consumption	W	220	300 or 600*
Operating voltage range	V DC	24 - 800	
Main dimension	mm	160 x 324 x 378	173 x 398 x 335

*Depending on model

ELECTRICAL HVAC HORIZONTAL EVAPORATOR



- Vertically mounted hybrid evaporator for conventional A/C with PTC heating element
- Features with directional scrolls which can be pivoted to direct the air in the right direction
- Also available as non-electric version with water heat exchanger

Version	Super K EHVAC	Kool EHVAC	Falkon EHVAC	
Heating performance	kW	up to 4		
Cooling performance	kW	3.5	4.5	7.7
Airflow	m³/h	440	520	660
Electrical consumption	W	100	180	360
Operating voltage range	V DC	24 - 800		
Main dimension	mm	216 x 368 x 137	261 x 384 x 158	297 x 432 x 167

ROOFTOP EHVAC UNIT - RK9



- Compact system with integrated evaporator, condenser, dryer filter and PTC heating element
- Available also as A/C version with integrated electrical compressor
- Ideal for small series production or vehicles that cannot accommodate a compressor
- Extremely simple retrofitting

Version	RK9 EHVAC			
Heating performance	kW	6		
Cooling performance	mm	7		
Airflow	m³/h	530		
Weight	kg	35		
Main dimension	mm	1.101 x 580 x 250		

Our entire product portfolio is available in our heating and air conditioning catalog.

FUEL OPERATED HEATING SOLUTIONS



FUEL OPERATED WATER HEATERS

- Pre-heat both - the vehicle and the engine interior
- Pre-heating reduces engine wear due to reduced cold starts and saves fuel and money
- Pre-heated cabins defrost the windshield and secure safe operation

HYDRONIC S3



Version [Diesel, 12 V]	Economy D4E	Economy D5E
Heating performance kW	1.3 to 4.3	1.3 to 5.0
Main dimension mm	215 x 91 x 180 [With straight connection fittings]	
Weight kg	2.0	
Fuel consumption l/h	0.53	0.59
Interfaces	CAN/S+ or CAN/LIN	

HYDRONIC M



Version [Diesel, 12 V]	M8 Biodiesel*	M10	M12
Heating performance kW	1.5 to 8.0	1.5 to 9.5	1.2 to 12.0
Main dimension mm	331 x 138 x 221		
Weight kg	6.2		
Fuel consumption l/h	0.18 - 0.9	0.18 - 1.2	0.15 - 1.5
Interfaces	LIN		

* 100% biodiesel compatible in accordance with FAME DIN EN 14214

FUEL OPERATED AIR HEATERS

AIRTRONIC S3 / M3



- Extremely fast air heating
- Low energy consumption – ideal for long heating periods while the vehicle is at standstill
- Integrated altitude sensor: automatic altitude adjustment up to 5,500 m

Version [Diesel, 12 V]	S3 Commercial	M3 Commercial
Heating performance kW	0.85 to 2.2	1.05 to 4.0
Main dimension mm	310 x 115 x 122	376 x 140 x 150
Weight kg	2.5	4.5
Fuel consumption l/h	0.1 - 0.27	0.12 - 0.49
Interfaces	CAN/S+	



| Our entire product portfolio is available in our heating and air conditioning catalog.

CABIN PRESSURIZATION SYSTEMS

PROTECTS THE DRIVER FROM POLLUTANTS AND DUST AND CAN BE COMBINED WITH EACH VEHICLE HVAC SYSTEM!

The pressurization system is connected to the existing HVAC system of the cabin. Depending on the filter it keeps pollutants (Category 4) and dust (Category 2) out of the air and creates overpressure in the cabin to protect drivers. This is in accordance with EN15695-1 & EN15695-2



THERE IS A VERSION WITH ONE FILTER K PROTEC AND A VERSION WITH UP TO TWO FILTERS K PROTEC MODULAR AVAILABLE.

K PROTEC - SINGLE FILTER CATEGORY 4 SYSTEM USAGE FOR AEROSOLS & VAPORS.



- Generates clean and safe cabin air for the vehicle operator
- A single filter system filters out pollutants and dust particles from the cab air.
- The overpressure generated prevents further pollutants entering from outside

Minimum overpressure	20 Pa
Minimum fresh air flow	30 m³/h
Certification	Enables cab certification in accordance with EN 15695 Category 4

K PROTEC MODULAR - MODULAR PRESSURIZATION SYSTEM

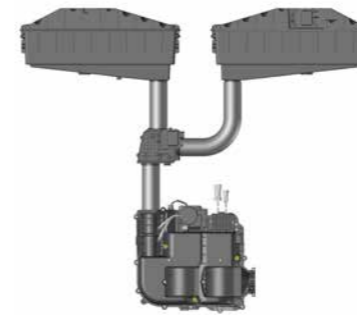

By using a system with two filters for the individual usage and switching between these filters uses for pollutants and dust (CAT 4 & CAT2 respectively) you can extend the lifetime of the pollutant filter tremendously which saves maintenance and therefore a lot of money for the user. These filters can be mounted horizontally or vertically to accommodate any space and fixation situation.

- Extra protection for filters
- Intelligent filter life calculation
- More power - 2 blowers in series
- Modulability
- Also as single filter system available

SYSTEM COMPONENTS:

Filter boxes:

- Completely closed box when unused to protect the filter against external pollution.
- Positive pressure inside Category 2 filter box when spraying to protect the category 2 filter from chemical pollution.

Selection box:

- The selection box is the part of the product that allows to select the filter corresponding to the operator's request.
- Designed to have the lowest pressure loss.

Pressurization box:

- 2 powerful variable speed blowers 2 x 300 W in series to overpressure large range of cabins.
- Integrated Dampers to reduce blowers vibration.

- Easy and modular installation
- Extend lifetime Category 4 filter saves money
- In line with EN 15695

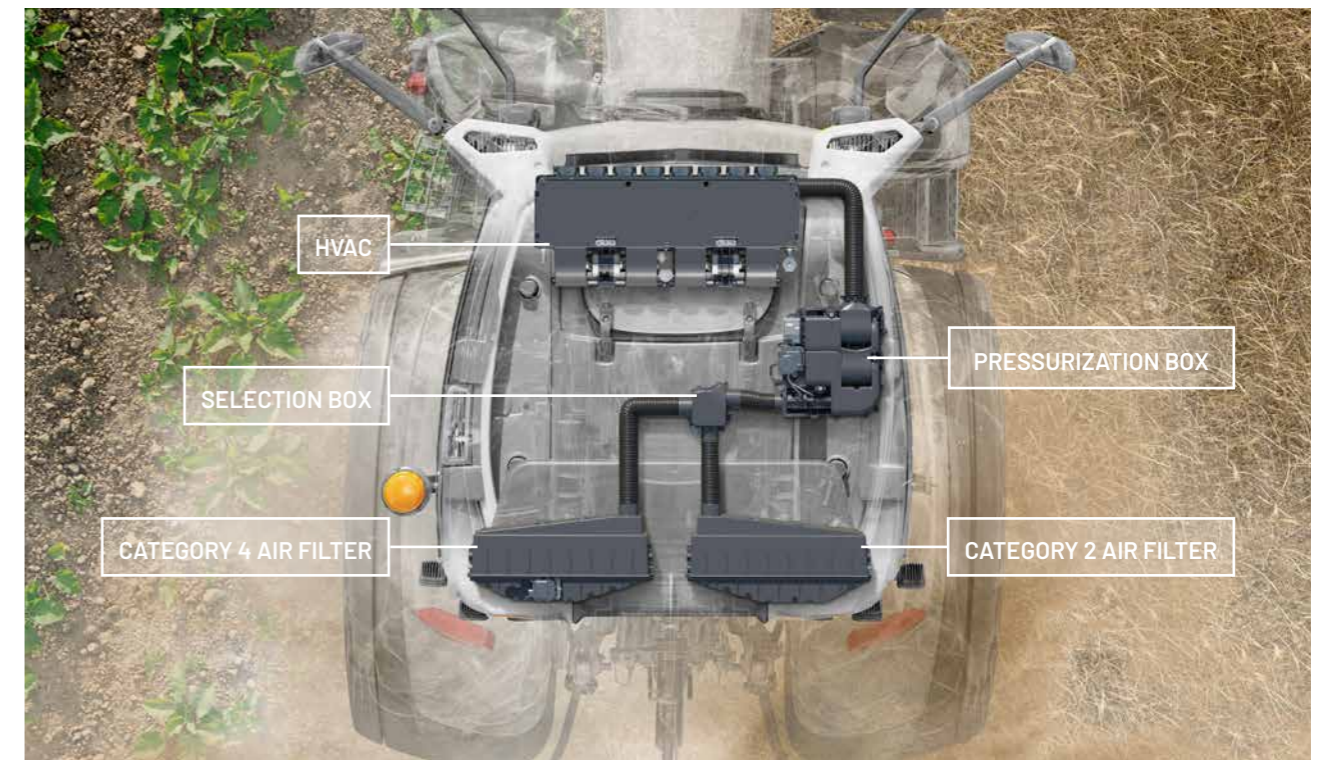

Our entire product portfolio is available in our heating and air conditioning catalog.

ACCESSORIES AND CONTROLS

OUTLETS

 You can choose the optimum items for your project from our huge range of outlets with different designs, functionalities and installation options.



TRIMLINE



FUEL OPERATED HEATING

CONTROL UNITS

 We offer control units for every product and requirement, from web-based devices with remote diagnosis for pre-heaters and combined control units for heating and cooling systems to automatic HVAC control units.



WEB-BASED CONTROL UNIT FOR HEATING



HEATING, A/C, HVAC

HVAC MANAGEMENT

 Our KAN-Box allows you to control different HVAC components via CAN bus in one system and to choose your individual preferred control option.



KAN-BOX

DIAGNOSTICS

 Services and tools for easy diagnosis are available for our products.



EASYSKAN

PRESSURIZATION ACCESSORIES

 The overpressure valve for pressurized cabins ensures an easy closing of the doors by a quick release of pressure created by the sudden closure of the door. The valves close to protect the cab up to 100 Pa or can be calibrated for other pressures on request.



OVERPRESSURE VALVE



GLOBAL FOOTPRINT

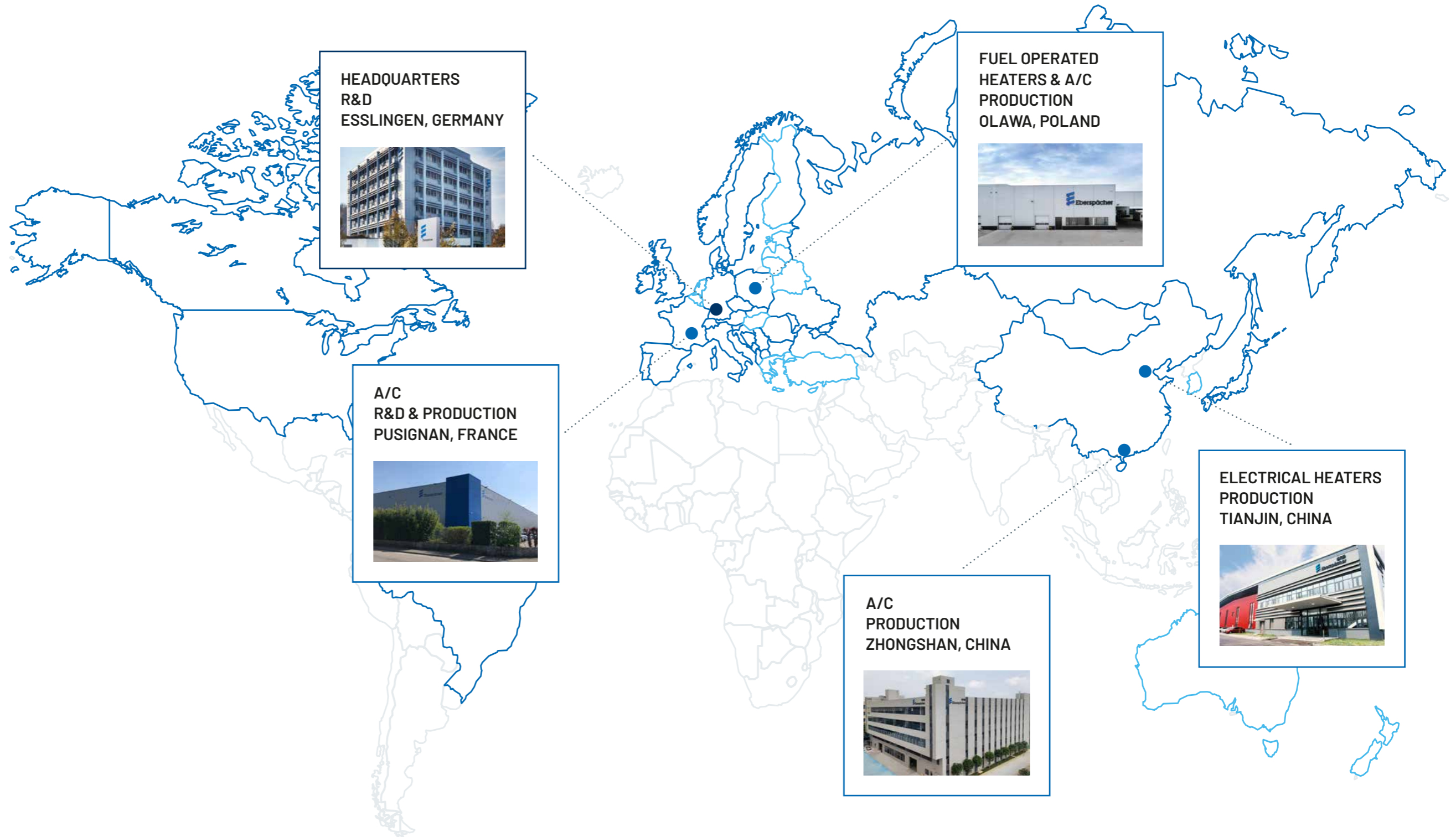

**HEADQUARTERS
R&D
ESSLINGEN, GERMANY**



**FUEL OPERATED
HEATERS & A/C
PRODUCTION
OLAWA, POLAND**



**A/C
R&D & PRODUCTION
PUSIGNAN, FRANCE**



**A/C
PRODUCTION
ZHONGSHAN, CHINA**



**ELECTRICAL HEATERS
PRODUCTION
TIANJIN, CHINA**



BRANCHES
ESSLINGEN, GERMANY

SUBSIDIARY

GENERAL AGENTS

EBERSPÄCHER CLIMATE CONTROL SYSTEMS GMBH
EBERSPÄCHERSTRASSE 24
73730 ESSLINGEN / GERMANY

PHONE: +49 711 939-00
FAX: +49 711 939-0634
info@eberspaecher.com
www.eberspaecher-climate.com